

Natjecanje instalatera grijanja i klimatizacije 2013.

Zadatak A: Model obilaska instalacije

Mat. - Cu 18x1

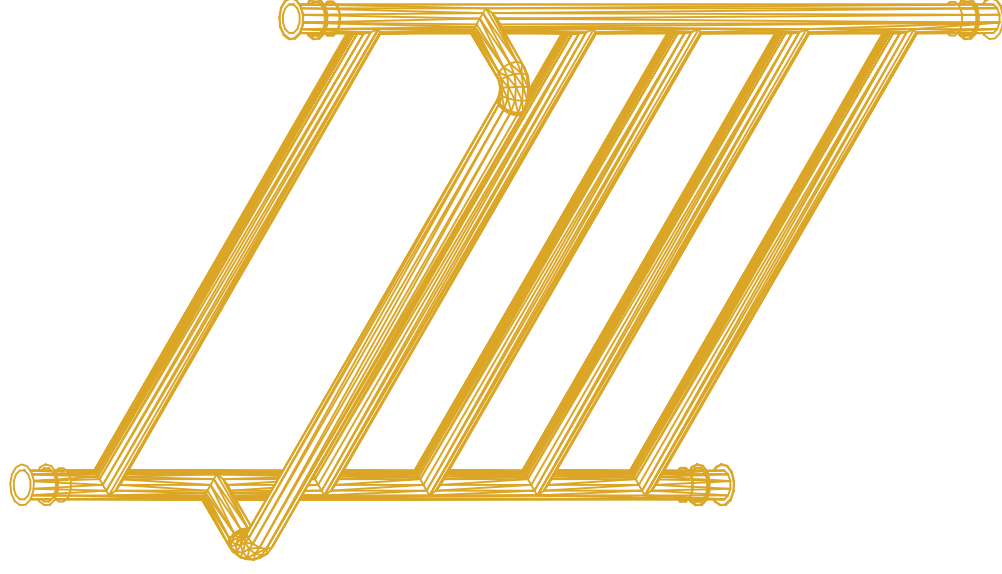
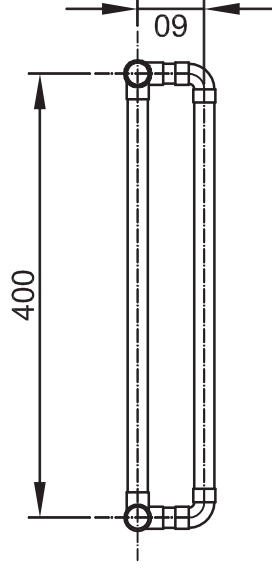
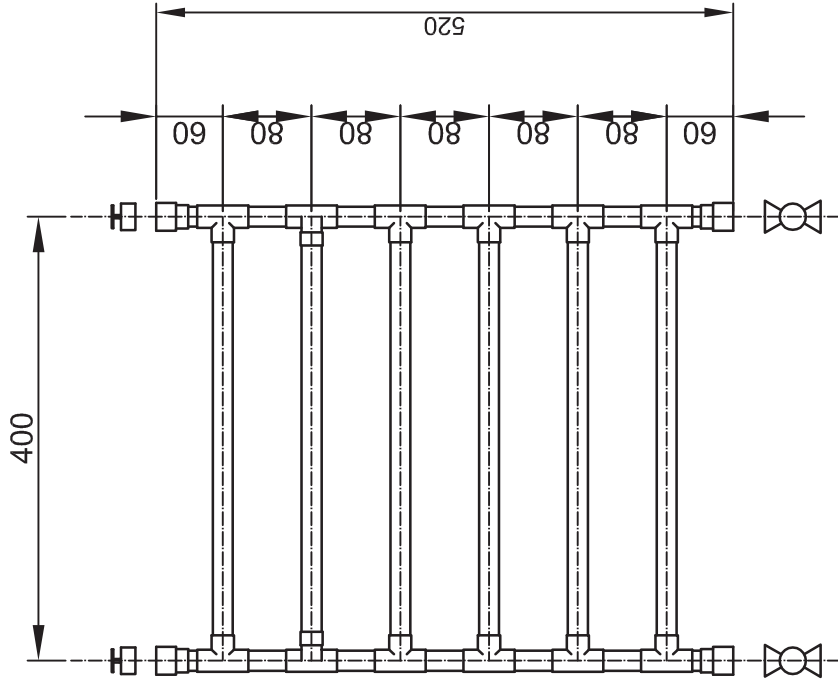
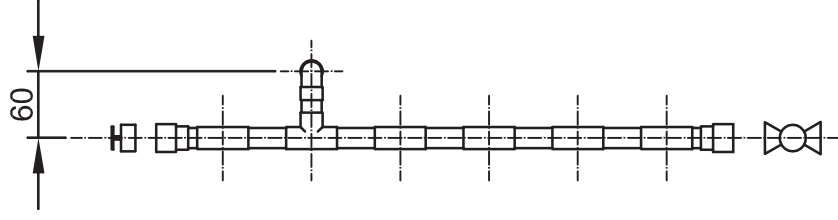

Natjecanje instalatera grijanja i klimatizacije 2013.

Zadatak B: Grijaće tijelo

Mat. - Cu 18x1

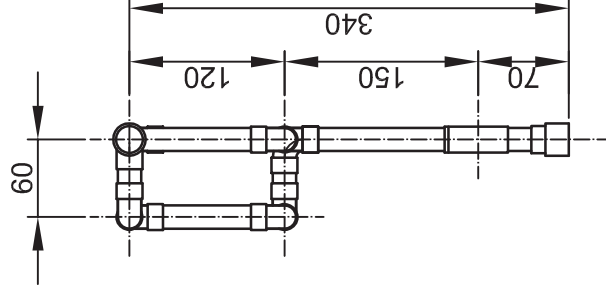
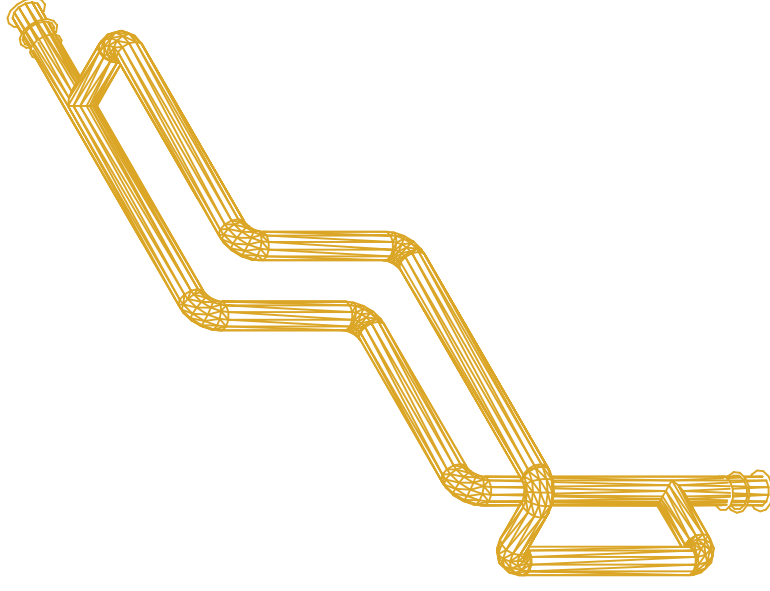
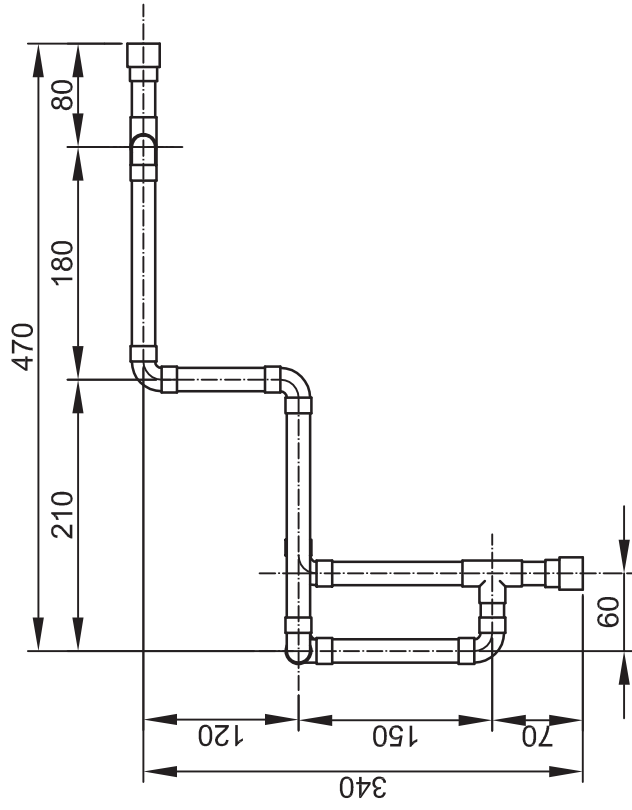
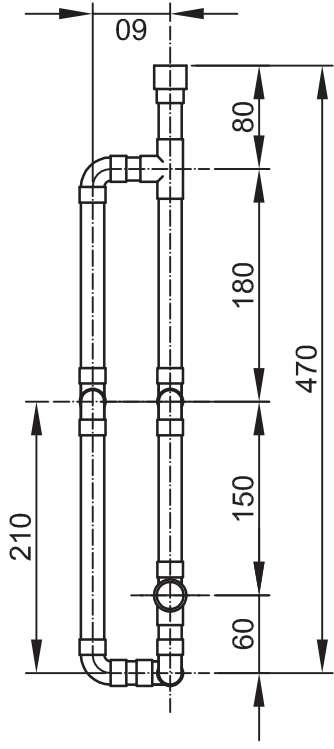

Natjecanje instalatera grijanja i klimatizacije 2013.

Zadatak C: Dio instalacije

Mat. - Cu 18x1

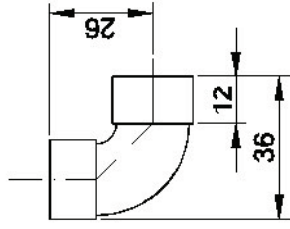

**Koljeno**

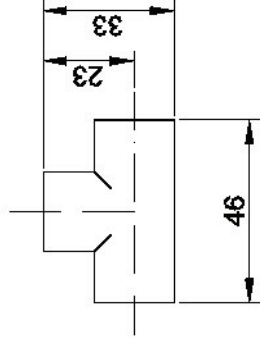

**T-komad**

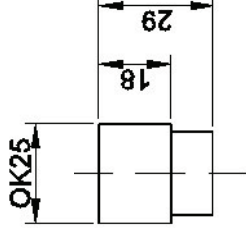

**MS prijelaz Ø18 - 1/2" NN**

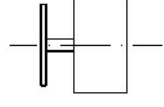

**Odzračnik 1/2"**

**Cu cijev 18x1**

Natjecanje instalatera grijanja i klimatizacije 2012.

Dimenzije fittinga

Mat. - Cu 18x1